



VENETIAN

absolute

**coulisse**

since 1992

All rights reserved. No part of this publication may be reproduced, stored in a retrieval system, or transmitted, in any form, by any means, electronic, mechanical, photocopying, recording, digital or otherwise without the written permission of the publisher. Although this publication has been composed with the utmost care, Coulisse B.V. does not accept any responsibility for damage due to mistakes and/or faults in this publication. Coulisse B.V. reserves the right to revise this publication and to revise and/or change its content at any time, without obligation to notify any person or entity of such revisions or changes. The most recent version replaces older versions of this publication. The most recent version is available at the Coulisse customer portal or your Coulisse contact. Please send your remarks and/or comments about this publication to [info@coulisse.com](mailto:info@coulisse.com).

© Copyright Coulisse

# SYSTEM BROCHURE



# B E I N S P I R E D

Enter the inspiring world of Coulisse window coverings. An exciting world of design inspired by fashion, art, architecture, nature, technology and beauty. A stimulating world that challenges our imagination about what else window coverings can be, offering safety, prevention, well-being, comfort and convenience in a way that embodies efficiency and simplicity. And a purposeful world that aims at being good for people, the planet and the environment.

Discover our world and be inspired.

## COLLECTIONS

We offer a wide range of collections, varying from screen, wood and aluminum to leather. All collections are inspired by fashion, art, architecture, nature, technology and beauty.



## MOTION

Our revolutionary automation concept, with ground-breaking motorization solutions for homes and buildings, is easy to install and simple to operate: it makes motorization accessible for everyone.



## SYSTEMS

Our modular technology is designed for great optics, ultimate convenience and maximum safety. Thanks to the modular design, endless configurations can be created with a minimum number of parts.



# T O T A L   C O N C E P T

Coulisse expresses its imaginative strength in inspiring collections and advanced system technology. As a one-stop-shop in window coverings, we provide seamless solutions that meet the ever-changing demands in the market. Our product range consists of a wide and complete variety of collections, systems and automation offering different functionality, looks and styles.

Discover our total concept.





# INDEX

Absolute by Coulisse	11
Absolute Venetian	13
Smart design	14
Smooth operation	15
Colors	17
Collections	19
Ladder tapes & cords	21
MOTION	23
Configurations	25
System specifications	26
Parts list	30
Accessories and child safety	43
Tools	48
About Coulisse	51

Please visit [my.coulisse.com](http://my.coulisse.com) for additional specifications, manuals, videos and calculation sheets or contact [info@coulisse.com](mailto:info@coulisse.com).



ABSOLUTE

by Coulisse

Imagine an indoor world full of light and peace. A place of safety, well-being and comfort. That is good for you and the world around you. Offering privacy and a pleasant climate. That pleases the senses at every time of the day. A personal space full of energy and life. Built on clean, smooth design. On simplicity, easiness and friendliness. On a modular world of window coverings.

Discover Absolute by Coulisse.





## ABSOLUTE VENETIAN

a design system for 50 mm blinds

- Modern design of aluminium head rail
- Designed for easy assembly
- Smooth operation
- From basic to full-option configurations
- Available in eight trend colors
- Valances in matching colors

## SMART DESIGN

valance in matching colors

- Valances available in slat and bottom bar matching colors

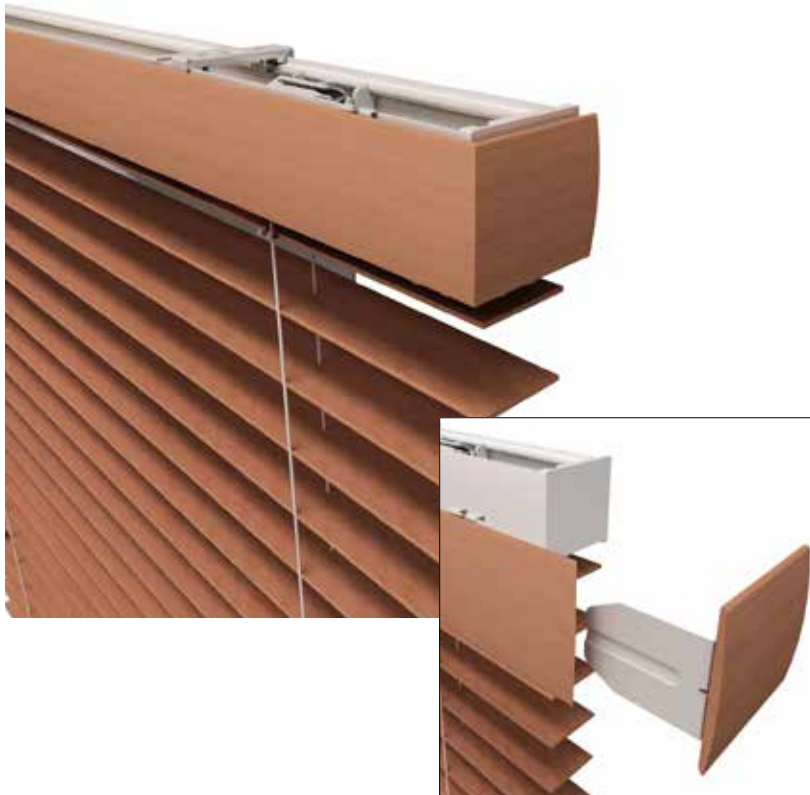

- Easy to assemble and disassemble with special valance clip
- Less chance of transport damage due to installation on location



## SMOOTH OPERATION

### heavy duty tilter

- Special tilter with a brass worm for large absolute venetian systems
- Results in smooth tilting and seamless closing of the slats
- The perfect solution for systems with 65mm slats









COLORS  
for the head rail



White Pearl

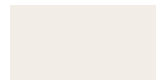

Sand



Camel



Cloud



Red Cherry



Raisin



Chocolate



Charcoal

Slats available in colors to match



COLLECTIONS  
of various materials

ALUMINIUM



Aluminium



Aluminium Perforated

VENEER



Luxury Exotic



Luxury Lounge



Luxury Rustic

BAMBOO



Bamboo Natural

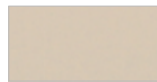

Bamboo Painted

WOOD



Classic Wood



Classic Renew

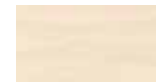

Elegant Wood

LEATHER



Leather



Elegant Wood Glossy



Frosted Wood



Frosted Wood Duo



Pure Wood  
Natural/Intense

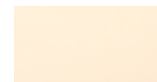

Pure Wood Glossy





LADDER TAPES & CORDS  
for 50 mm venetian blinds

CORDS

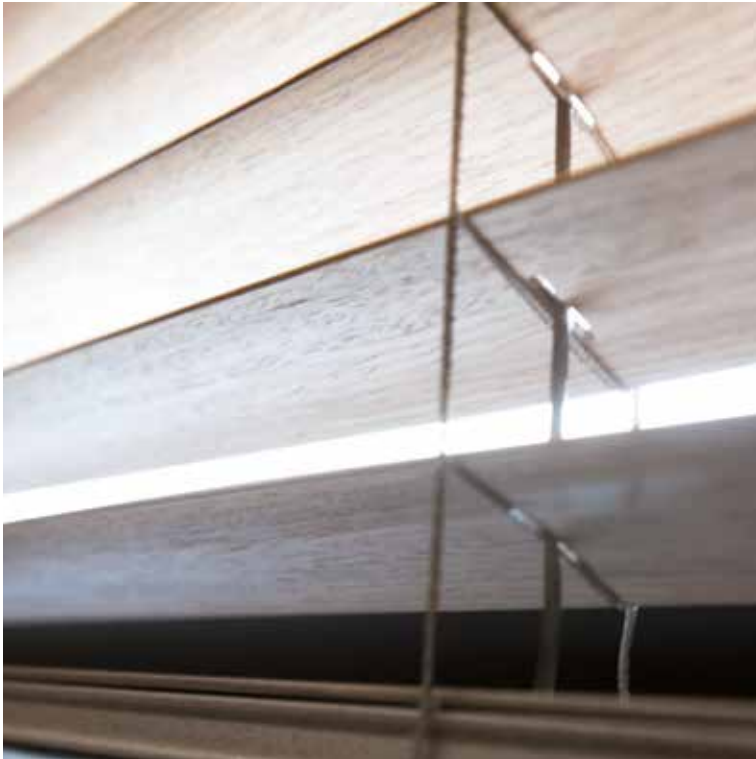

TAPES

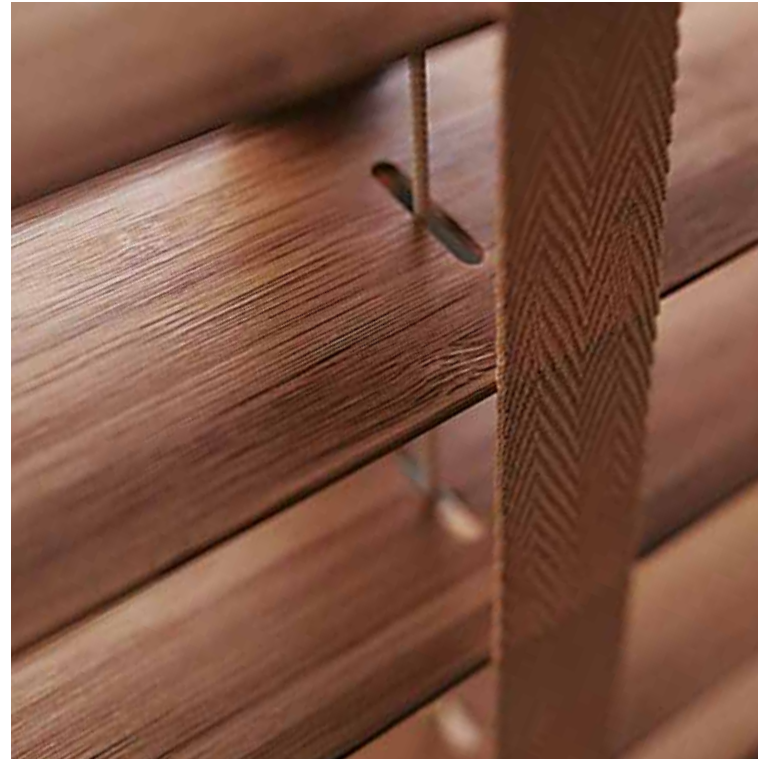

Visit [my.coulisse.com](http://my.coulisse.com) for the full range





# MOTION

## automation for blinds

MOTION is a ground-breaking window coverings automation solution that makes motorized shades available to everyone. With accessible motors for the home to advanced solutions for commercial buildings, MOTION offers the perfect motorization for any requirement.



**Video**  
MOTION, automation for  
blinds by Coulisse





## CONFIGURATIONS

from basic to full-option

### CORD-LOCK AND TILTER

- Cord for tilting and lifting
- Smooth operation

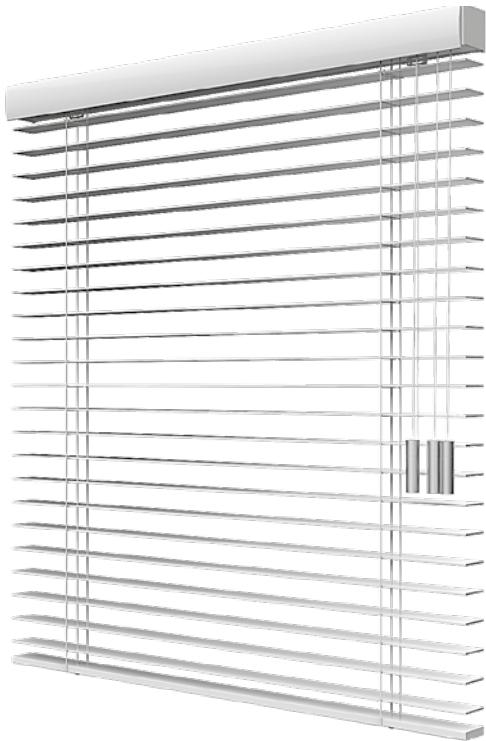

### MONO-CONTROL

- One chain for tilting and lifting
- Gearing for heavy blinds
- No cords in the recess



### MOTORIZED TILT AND LIFT

- Ideal for big sizes
- Aluminium head rail (for extra silent operation)
- Silent motor option available

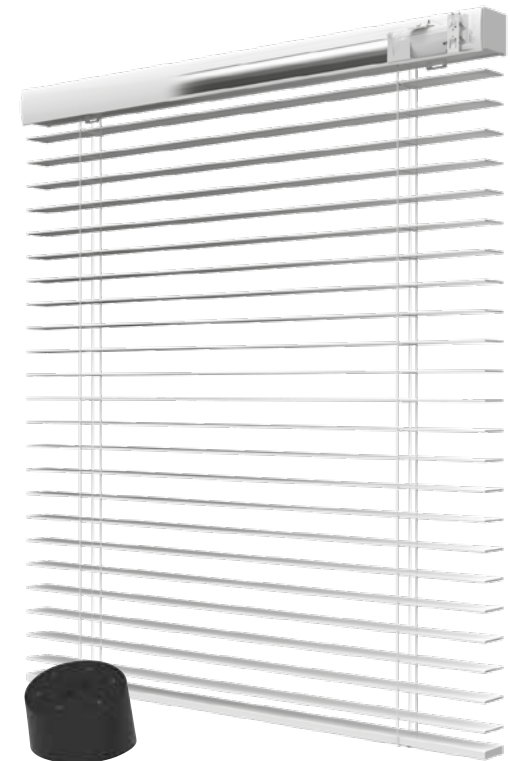

# SYSTEM SPECIFICATIONS

## ABSOLUTE VENETIAN BLIND

	Operation	Max. weight pulling cord		Max. weight blind		Min. dist. A <sup>5</sup>		Min. width <sup>4</sup>	
		kg	lb	kg	lb	mm	in	mm	in
1	Cord-lock and tilter	2,5	5.5	12,0	26.5	115 (140) <sup>1</sup>	4.5 (5.5) <sup>1</sup>	330	13.0
2	Mono control (chain)	2,5	5.5	12,0	26.5	80	3.1	335	13.2
3	Motorized tilt and lift	2,5	5.5	15,0	33.1	80	3.1	5702 (680) <sup>3</sup>	22.42 (26.8) <sup>3</sup>

<sup>1</sup> When using double cordlock (max number of cords in cordlock = 4 cords)

<sup>2</sup> Mechanical motor

<sup>3</sup> Electronic motor

<sup>4</sup> Extra weight in bottom bar may be necessary

<sup>5</sup> Max. distance A of 200 mm is recommended

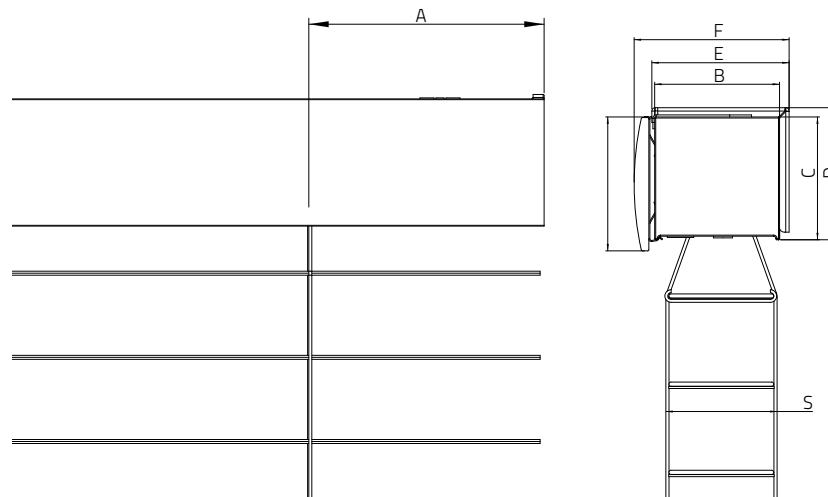

# SYSTEM SPECIFICATIONS

## MEASUREMENTS

Slat material	Max. width		Max. height		Max. surface	
	m	in	m	in	m <sup>2</sup>	ft <sup>2</sup>
Wood	2,7	106.3	4,0	157.5	6,0 (8,0)*	64.6 (86.1)*
Aluminium	5,8	228.3	5,0	196.9	12,0 (15,0)*	129.2 (161.5)*

Dimension B		Dimension C		Dimension D		Dimension E		Dimension F		Dimension S	
mm	in	mm	in	mm	in	mm	in	mm	in	mm	in
60,0	2.4	59	2.3	63	2.5	65	2.6	74	2.9	25 / 35 50 / 65	1 / 1 <sup>1/2</sup> 2 / 2 <sup>1/2</sup>

# SYSTEM SPECIFICATIONS

## NUMBER OF PULLING CORDS AND LADDER TAPES/CORDS

Max. width	in	Option reduce number of pulling cords	number of ladder tapes/ cords
m	in		
.... - 0,9	.... - 35.4	2	2
0,9 - 1,4	35.4 - 55.1	2	3
1,4 - 1,9	55.1 - 74.8	2	4
1,9 - 2,4	74.8 - 94.5	3	5
2,4 - 2,9	94.5 - 114.2	4	6
2,9 - 3,4	114.2 - 113.9	4	7
3,4 - 3,9	113,9 - 153,5	6*	8
3,9 - 4,4	153.5 - 173.2	5*	9
4,4 - 4,9	173.2 - 192.9	8*	10
4,9 - 5,4	192.9 - 212.6	6*	11
5,4 - 5,8	212.6 - 228.3	8*	12

\* max 4 cords / cordlock

## MAXIMUM WIDTH OF LADDER TAPE

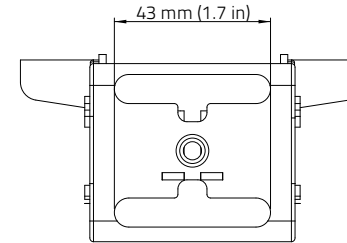

## NUMBER OF BRACKETS

Width		Max. number of brackets
m	in	
.... - 1,0	.... - 39.4	2
1,0 - 2,0	39.4 - 78.7	3
2,0 - 3,0	78.7 - 118,1	4
3,0 - 4,0	118.1 - 157.5	5
4,0 - 5,0	157.5 - 196.9	6
5,0 - 5,8	196.9 - 228.3	7



PARTS LIST GENERAL COMPONENTS

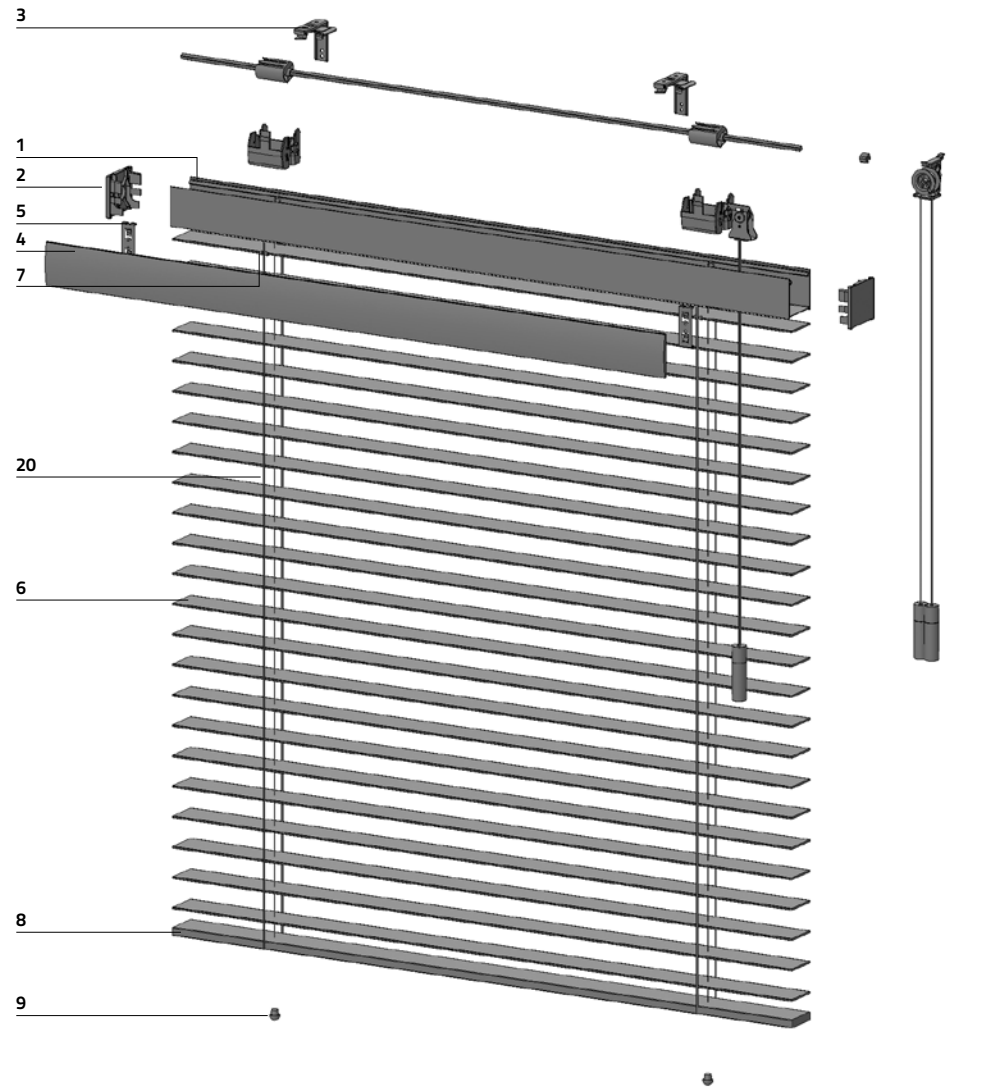

For cords and chains accessories see accessories brochure

PARTS LIST GENERAL COMPONENTS

	Pos	Code	Description	Inner Carton	Outer Carton	
HEAD RAIL	1	HC50-01-XX	Head rail aluminium 50 mm 580 cm various colours	46,4 mtr/carton	46,4 mtr/carton	
	2	HC50-11-XX	End cap 50 mm various colours	1 pcs/bag	1 pcs/carton	
BRACKETS	3	HC50-12	Swivel bracket 50 mm zinc	100 pcs/bag	200 pcs/carton	
	3	HC50-14	Wall bracket 65 mm zinc	100 pcs/bag	200 pcs/carton	
VALANCE	4	-	Valance wood, for collections see my.coulisse.com			
	5	HC50-06	Valance clip	200 pcs/bag	2000 pcs/carton	
	/	HC50-16	Venetian valance miter angle bracket	100 set/carton	100 set/carton	

PARTS LIST GENERAL COMPONENTS

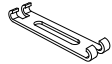
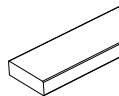
	Pos	Code	Description	Inner Carton	Outer Carton	
SLAT	6	-	Slat wood, for collections see my.coulisse.com			
	<hr/>					
SLAT CLIPS	7	WPSC50TR	Slat clip 50 mm translucent	500 pcs/bag	10000 pcs/carton	
	<hr/>					
	7	WPSC65TR	Slat clip 65 mm translucent	500 pcs/bag	10000 pcs/carton	
<hr/>						
BOTTOM RAIL	8	-	Bottom rail wood, for collections see my.coulisse.com			
	<hr/>					
	9	WPBBXX WPBBXX	Button for bottom rail wood various colours Button for bottom rail wood glossy various colours	1000 pcs/bag 1000 pcs/bag	4000 pcs/carton 4000 pcs/carton	
<hr/>						
	/	WWO-N-XX	Nail various colours	500 pcs/bag	25000 pcs/carton	
<hr/>						





PARTS LIST CORD LOCK AND TILTER

Cord lock and tilter

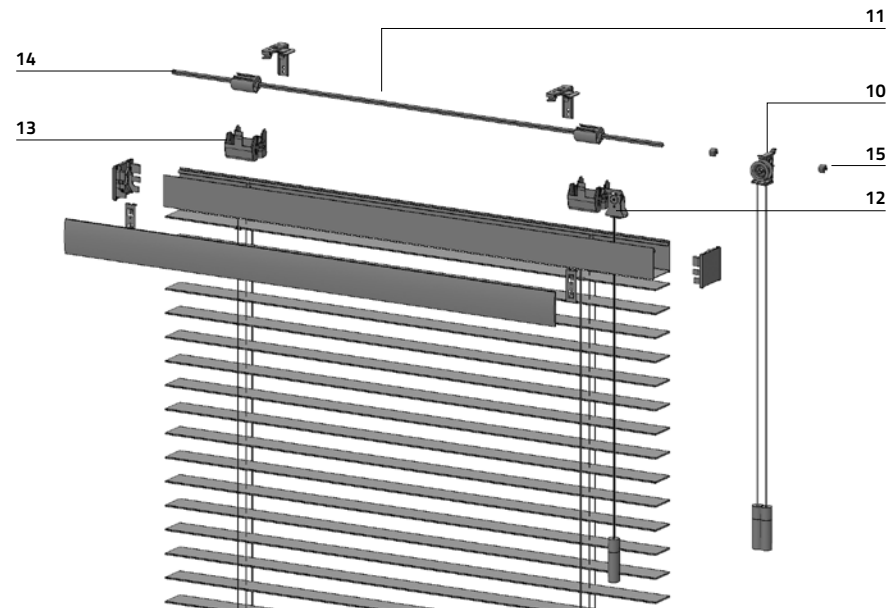

PARTS LIST CORD LOCK AND TILTER

Pos	Code	Description	Inner Carton	Outer Carton	
10	HC50-02 HC50-02	Cord tilter Cord tilter with CNC worm	50 pcs/bag 50 pcs/bag	250 pcs/carton 250 pcs/carton	
11	H50-10	Rod metal 6 mm x 6 mm 300 cm	90 mtr/carton	90 mtr/carton	
12	HC50-04	Cord lock	250 pcs/bag	500 pcs/carton	
13	HC50-05-H	Tape roll support plastic	50 pcs/bag	250 pcs/carton	
/	H21	Ladder cord clip aluminium	5000 pcs/bag	200000 pcs/carton	
14	HC50-03	Tape roll plastic	100 pcs/bag	500 pcs/carton	
15	H50-11	Stopper	100 pcs/bag	10000 pcs/carton	



CORD LOCK AND TILTER

PARTS LIST CHAIN CONTROL

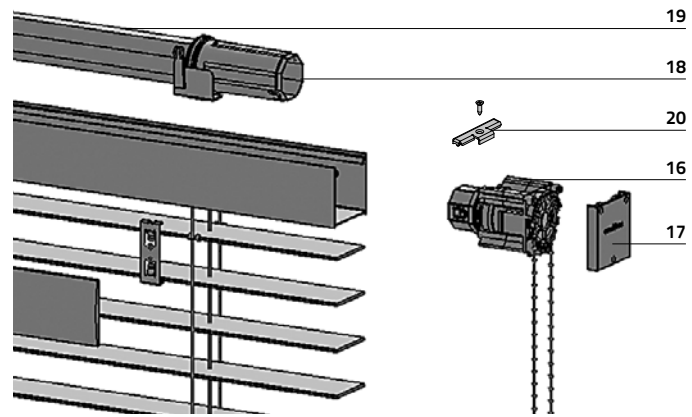
Chain control

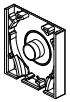

PARTS LIST CHAIN CONTROL

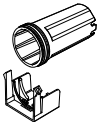
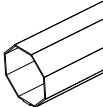
Pos	Code	Description	Inner Carton	Outer Carton	
16	UCM-02	Universal chain mechanism 1.5 50 mm	1 set/bag	10 set/carton	
17	HC50-08	End cap for universal chain mechanism various colours	1 pcs/bag	1 pcs/carton	
/	HC50-13	Fixation plate motor bracket steel galvanized	50 pcs/bag	500 pcs/carton	
18	ABC-14	Spool and support	20 set/carton	120 set/carton	
19	ABC-16	Tube octagonal 580 cm	23,2 mtr/carton	23,2 mtr/carton	

CHAIN CONTROL

## REMOTE MOTION



# CM-10

Tubular motor 35 mm



Motor	Description	Motor diameter	Tube compatibility	Torque	Speed	Battery Capacity	Power supply	Input	Features	Certificates
CM-10-QC	Tubular motor	35 mm	42-50-65-80 mm	8 Nm	15 rpm	n/a	~			CE
CM-10-QC120	Tubular motor	35 mm	42-50-65-80 mm	8 Nm	17 rpm	n/a	~			

WIRED MOTION



# CM-10

Tubular motor 35 mm









Motor	Description	Motor diameter	Tube compatibility	Torque	Speed	Battery Capacity	Power supply	Input	Features	Certificates
CM-10-QMC	Tubular motor	35 mm	42-50-65-80 mm	8 Nm	15 rpm	n/a	~		   	CE
CM-10-QMC120	Tubular motor	35 mm	42-50-65-80 mm	8 Nm	17 rpm	n/a	~		   	

PARTS LIST MOTORIZATION

Pos	Code	Description	Inner Carton	Outer Carton		
REMOTE MOTION	/	CM-10-QC CM-10-QC120	Tubular motor Radio 35 mm 230VAC silent 8Nm 15rpm Tubular motor Radio 35 mm 120VAC silent 8Nm 17rpm	1 pcs/carton 1 pcs/carton	6 pcs/carton 6 pcs/carton	
	/	HC50-13	Fixation plate motor bracket steel galvanized	50 pcs/bag	500 pcs/carton	
	/	HC50-17-ABC	Universal spider bracket	50 pcs/bag	500 pcs/carton	
	/	HC50-18-ABC	Drive plug octagonal tube	12 pcs/bag	240 pcs/carton	
	/	HC50-19-ABC	Endplug octagonal tube	100 pcs/bag	500 pcs/carton	



PARTS LIST MOTORIZATION







Pos	Code	Description	Inner Carton	Outer Carton	
/	CM-10-QMC	Tubular motor mechanical 35 mm 230VAC silent 8Nm 15rpm	1 pcs/carton	6 pcs/carton	
	CM-10-QMC120	Tubular motor mechanical 35 mm 120VAC silent 8Nm 17rpm	1 pcs/carton	6 pcs/carton	
/	HC50-13	Fixation plate motor bracket steel galvanized	50 pcs/bag	500 pcs/carton	
/	HC50-17-ABC	Universal spider bracket	50 pcs/bag	500 pcs/carton	
/	HC50-18-ABC	Drive plug octagonal tube	12 pcs/bag	240 pcs/carton	
/	HC50-19-ABC	Endplug octagonal tube	100 pcs/bag	500 pcs/carton	
/	HC50-20-ABC	Crown mechanical motor	100 pcs/bag	1000 pcs/carton	

WIRED MOTION

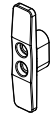

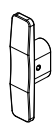

# ACCESSORIES AND CHILD SAFETY

## PARTS LIST ACCESSORIES AND CHILD SAFETY

Pos	Code	Description	Inner Carton	Outer Carton	
/	CSD04-XX*	Safety tensioner	12 pcs/bag	192 pcs/carton	
/	CSD05-XX*	Cord cleat plastic	250 pcs/bag	1000 pcs/carton	
/	CSD06-XX*	Safety clip plastic	250 pcs/bag	1000 pcs/carton	
/	CSD07-XX*	Safety clip alloy	12 pcs/bag	288 pcs/carton	
/	CSD09-XX*	Cordcleat zinc alloy	12 pcs/bag	288 pcs/carton	
/	CSD10-ST-XX*	Cordcleat lux - wood stick	2000 pcs/carton	2000 pcs/carton	
/	CSD10-XX*	Cordcleat lux - wall bracket	12 pcs/bag	288 pcs/carton	
/	CSD13-TR	Cordstopper medium transparant	500 pcs/bag	10000 pcs/carton	

\*more options on [my.coulisse.com](http://my.coulisse.com)

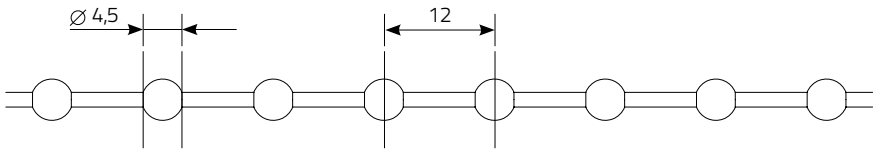
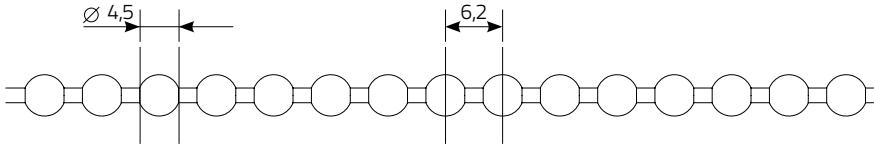
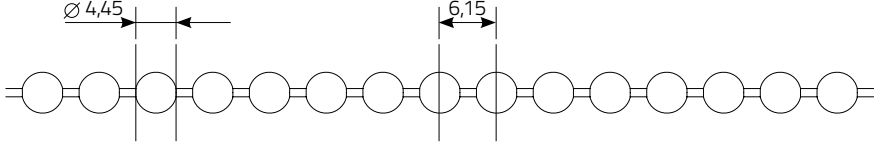

PARTS LIST ACCESSORIES AND CHILD SAFETY

Pos	Code	Description	Inner Carton	Outer Carton	
/	CSD15-XX*	Safety tassel	1000 pcs/bag	2000 pcs/carton	
/	H13-14*	Pulling cord 1.4 mm	500 mtr/roll	10000 mtr/carton	
/	PL50-12*	Pulling cord XL Pleat 1.4 mm	1000 mtr/roll	1000 mtr/roll	
/	RBXX* RBXX-C-G*	Endless operating chain plast. 4.5 mm 12 mm Endless operating chain plast. 4.5 12 mm	100 pcs/bag 100 pcs/bag	1000 pcs/carton 500 pcs/carton	
/	RBXX-DP*	Endless operating chain plast. 4.5 mm 6.2 mm	100 pcs/bag	500 pcs/carton	
/	RBXX-M*	Endless operating chain metal 4.45 mm 6.15 mm	10 pcs/bag	100 pcs/carton	

VENETIAN ACCESSORIES

\*more options on [my.coulisse.com](http://my.coulisse.com)

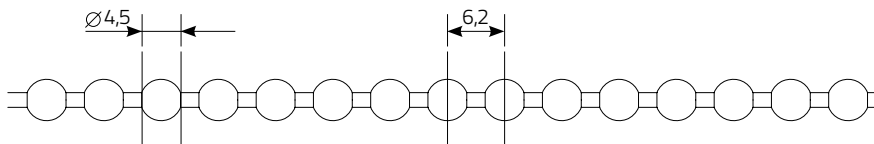
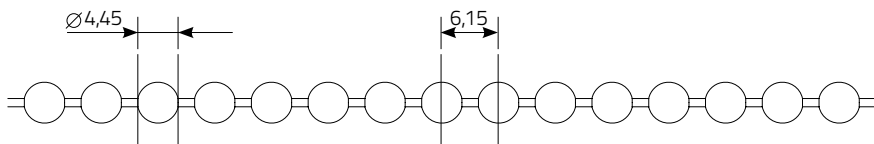
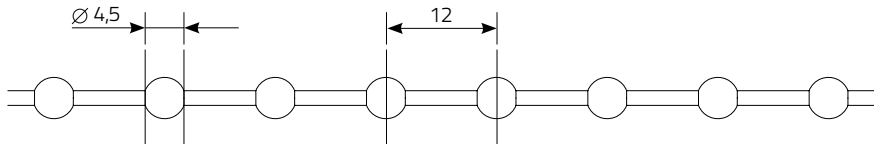



PARTS LIST ACCESSORIES AND CHILD SAFETY

Pos	Code	Description	Inner Carton	Outer Carton	
/	V15DP*	Operating chain plastic 4.5 mm 6.2 mm	250 mtr/roll	1000 mtr/carton	
					
/	V15M*	Operating chain metal 4.45 mm 6.15 mm	150 mtr/roll	600 mtr/carton	
					
/	V15P	Operating chain plastic 4.5 mm 12 mm white	250 mtr/roll	2000 mtr/carton	
	V15PC	Operating chain plastic 4.5 mm 12 mm translucent	250 mtr/roll	2000 mtr/carton	
	V15PC-G	Operating chain plastic 4.5 mm 12 mm translucent grey	250 mtr/roll	2000 mtr/carton	
	V15P-G	Operating chain plastic 4.5 mm 12 mm grey	250 mtr/roll	2000 mtr/carton	
					
/	WPLC50XX*	Ladder cord 50 mm	400 mtr/carton	3200 mtr/carton	
/	WPLC65XX*	Ladder cord 65 mm	300 mtr/carton	1800 mtr/carton	

\*more options on [my.coulisse.com](http://my.coulisse.com)

VENETIAN ACCESSORIES









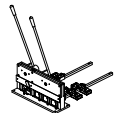

PARTS LIST ACCESSORIES AND CHILD SAFETY

Pos	Code	Description	Inner Carton	Outer Carton	
/	WPLT50XX*	Ladder tape system 50 mm Width 25 mm	50 mtr/roll	500 mtr/carton	
/	WPLT50XX38*	Ladder tape system 50 mm Width 38 mm	50 mtr/roll	500 mtr/carton	
/	WPLT65XX38*	Ladder tape system 65 mm Width 38 mm	50 mtr/roll	500 mtr/carton	
/	WPPC25XX*	Pulling cord 1.7 mm	500 mtr/roll	6000 mtr/carton	
/	WPPC50XX*	Pulling cord 2.8 mm	300 mtr/roll	3600 mtr/carton	

VENETIAN ACCESSORIES

\*more options on [my.coulisse.com](http://my.coulisse.com)

PARTS LIST TOOLS

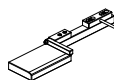
	Pos	Code	Description	Inner Carton	Outer Carton	
HEADRAIL PUNCH	/	M-HC50-01MP	Manual punch tool housing for venetian head rails	1 pcs/crate	1 pcs/crate	
	/	M-HC50-01AT	Venetian punch die automated HR PUNCH	1 pcs/crate	1 pcs/crate	 
	/	M-HC50-01CL	Venetian punch die cordlock	1 pcs/crate	1 pcs/crate	 
	/	M-HC50-01LC	Venetian punch die ladder cord PUNCH	1 pcs/crate	1 pcs/crate	 
	/	M-HC50-01LT	Venetian punch die ladder tape	1 pcs/crate	1 pcs/crate	 
CUTTING MOULD	/	M-HC50-05	Laddercord cutting mould	1 pcs/crate	1 pcs/crate	
	/	M-HC50-06	Laddertape cutting mould	1 pcs/crate	1 pcs/crate	



PARTS LIST TOOLS

	Pos	Code	Description	Inner Carton	Outer Carton	
DRILL MOULD	/	M-HC50-02	Drill mould head rail mechanical motor	1 pcs/carton	1 pcs/carton	
	/	M-HC50-03	Drill mould head rail electronic motor	1 pcs/carton	1 pcs/carton	
	/	M-HC50-04	Drill tool for octangular tube	1 pcs/carton	1 pcs/carton	
SLAT PUNCH	/	M-PT	Universal punch tool	1 pcs/crate	1 pcs/crate	
	/	MW-P50-65	Punch insert for M-PT 50 mm 65 mm wood	1 pcs/carton	1 pcs/carton	
	/	MW-S	Stopper for M-PT 25 50 65 mm wood	1 pcs/carton	1 pcs/carton	



**coulisse**

## ABOUT COULISSE

Since its establishment in 1992, Coulisse has grown into a leading international supplier of window coverings for both made-to-measure products and the DIY market. Our innovative strength is shown and expressed in inspiring collections and advanced system solutions. Our complete range offers customers endless possibilities to be distinctive in the market and to meet the ever-changing demands of end users.

Coulisse B.V. Vonderweg 48 7468 DC Enter The Netherlands  
t +31 547 85 55 55 e info@coulisse.com

coulisse.com