

Exactly my  
mood.



**HELLA**

Welcome  
to HELLA!



<b>Welcome to HELLA</b> .....	<b>2</b>
<b>The HELLA Group</b> .....	<b>6</b>
<b>Productportfolio</b> .....	<b>9</b>
<b>Terrace &amp; Garden</b> .....	<b>11</b>
Awnings .....	<b>12</b>
Pergolas .....	<b>14</b>
Conservatory blinds.....	<b>16</b>
<b>Sun protection outdoors &amp; indoors</b> .....	<b>19</b>
Outdoor blinds & exterior venetian blinds .....	<b>20</b>
Roller shutters .....	<b>22</b>
Facade blinds.....	<b>24</b>
Interior blinds.....	<b>26</b>
<b>Insect screens</b> .....	<b>29</b>
<b>Solutions for building shells</b> .....	<b>33</b>
TRAV®frame Soffit systems.....	<b>34</b>
Box systems.....	<b>36</b>
Top-mounted elements.....	<b>38</b>
<b>HELLA Control systems</b> .....	<b>41</b>
Control devices ONYX® .....	<b>42</b>
<b>References</b> .....	<b>47</b>
Living with HELLA .....	<b>50</b>
Working with HELLA .....	<b>54</b>
Our customers report .....	<b>58</b>
<b>HELLA</b> .....	<b>61</b>
HELLA highlights .....	<b>62</b>
60 years HELLA .....	<b>64</b>
Our vision and mission .....	<b>65</b>
Partnership with handshake quality .....	<b>67</b>



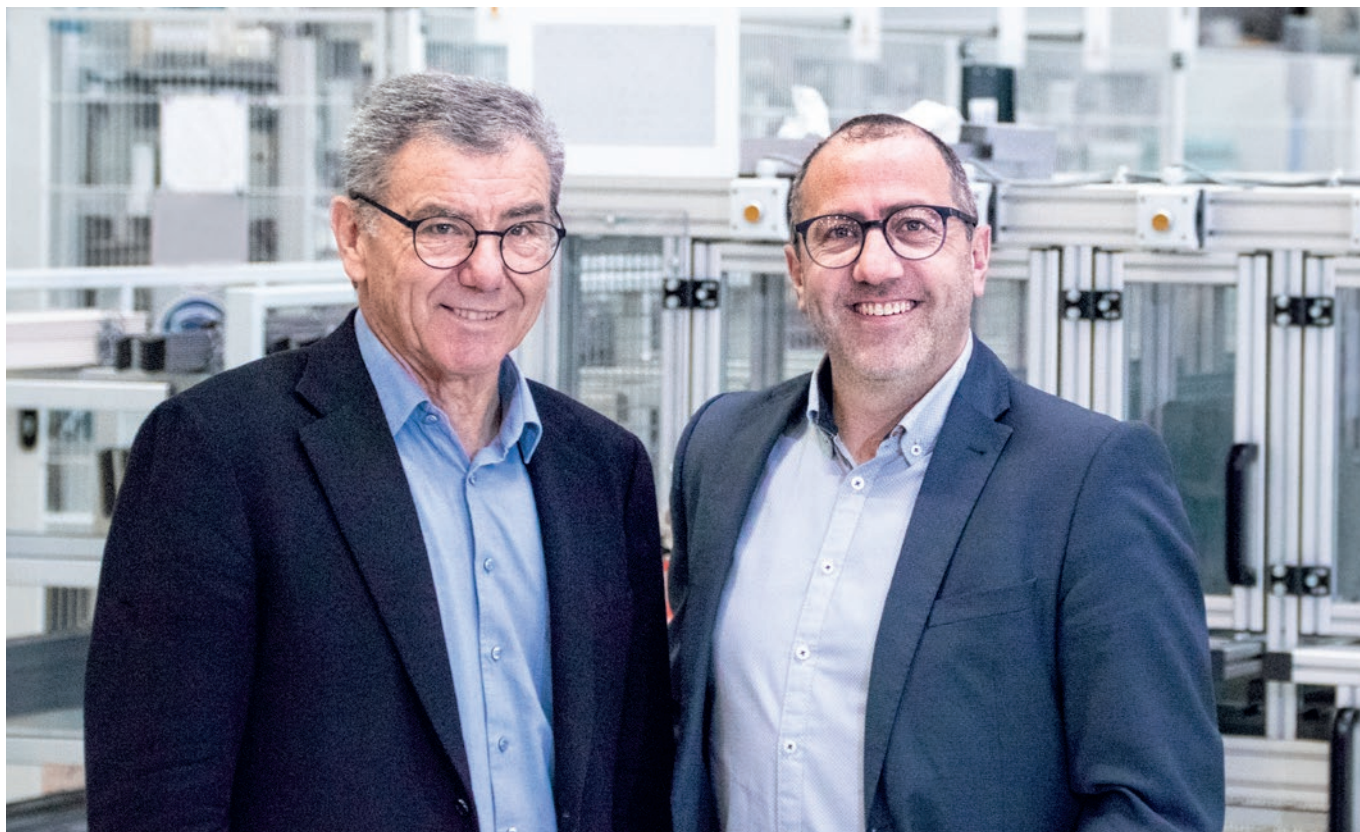

Franz and Andreas Kraler

At HELLA, we contribute our competence and experience from more than half a century of company history to the development and production of high-quality sun and weather protection systems.

Our head office and our origin are based in the Austrian Abfaltersbach, a small village in the East Tyrolian mountains. Influenced by the values of our home region like honesty and reliability, we have developed into one of Europe's leading brands for sun and weather protection as well as driving force for technologies and designs.

Our product range extends from sun and weather protection solutions for indoor and outdoor use to networked smart home systems for trend-setting residential and commercial buildings.

Our products help to control and dose sun light according to your requirements. They save energy, improve living comfort, increase productivity and extend your living space outdoors. See for yourself the variety of HELLA products!

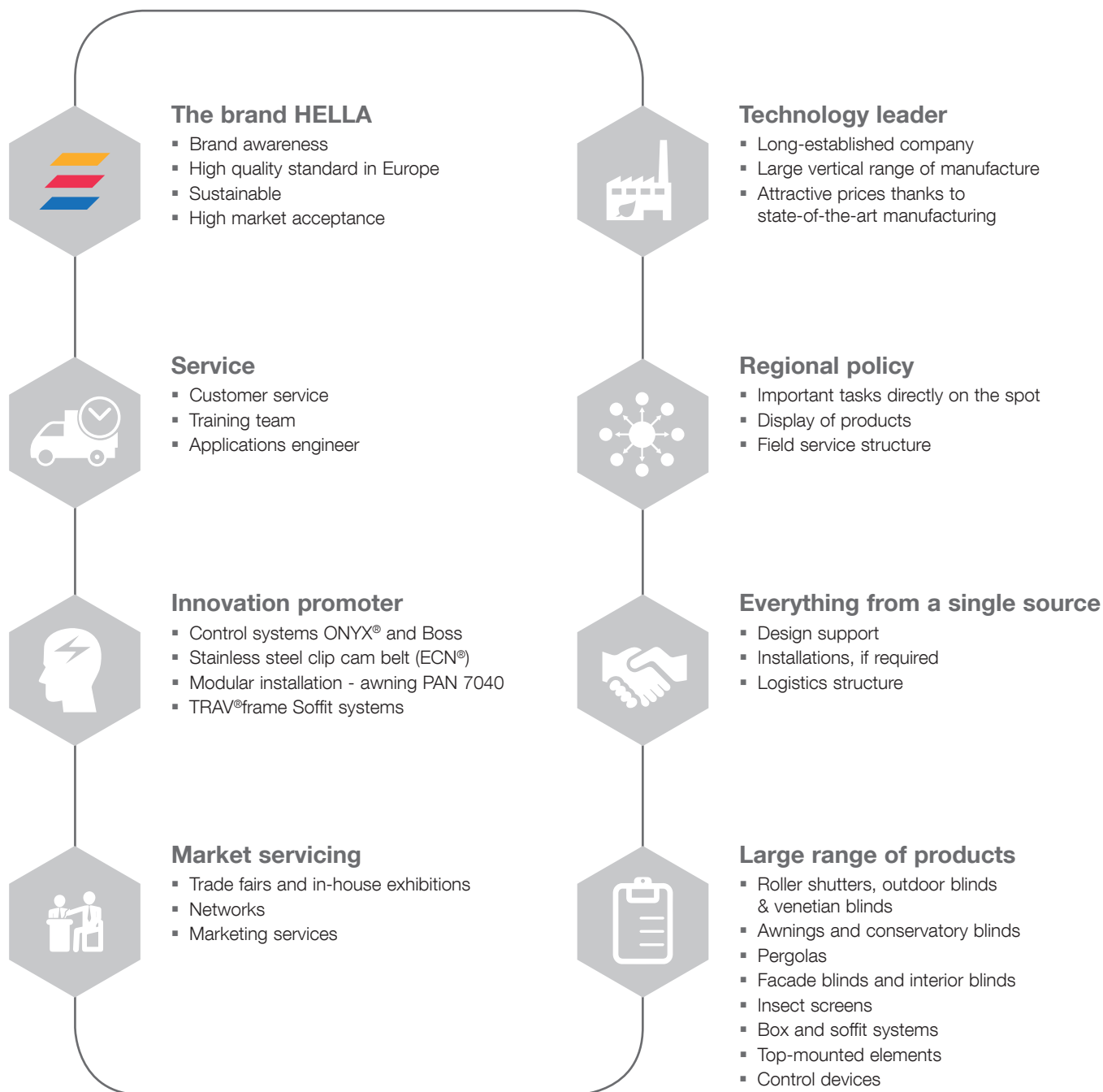

# The HELLA Group

An international enterprise  
with more than 1300 employees

With our products we combine quality with atmosphere, innovation with elegance and product diversity with mood. In more than half a century of company history we have been able to develop and deepen the right balance between light and shade for your well-being. Our products are produced in our European factories.

- **Sales locations**

- **Factories:**

- Abfaltersbach, AT
- Duisburg, DE
- Geislingen a. d. Steige, DE
- Werne, DE
- Wroclaw, PL
- Vysokov, CZ



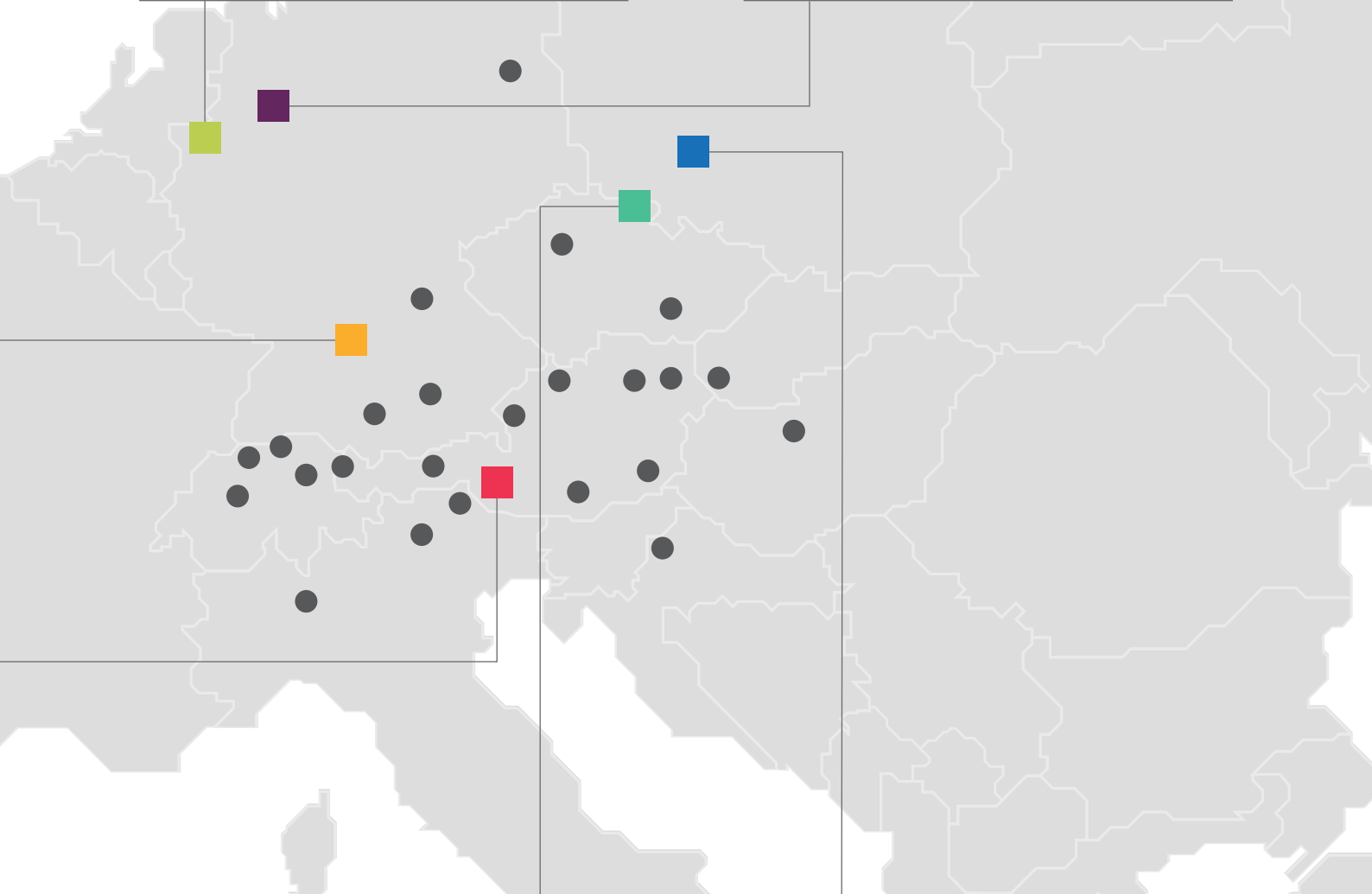







# Product portfolio

On the following pages you will find an overview of our full product assortment around your home. This ranges from sun and weather protection solutions for indoors and outdoors to interconnected smart home systems for trendsetting residential buildings and commercial properties.





# Terrace & Garden

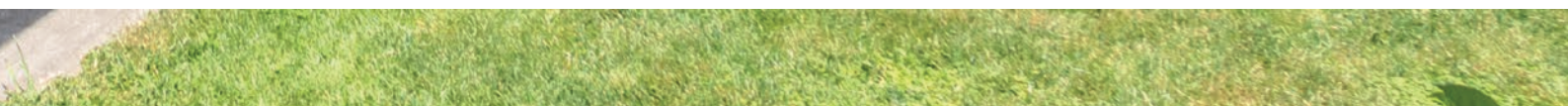



“Enjoy ideal light exactly where you need it with our LED lighting even in the evening.”

# Awnings

## Stylish outdoor living spaces

Mediterranean ease, alpine solidity, urban style, fancy or linear – an awning becomes a statement that emphasises the architecture and expands the built space functionally and aesthetically.

Awnings from HELLA fit in any architecture and, depending on the model, offer many extras and options: Crank handle or motor operation, weather sensors, valance or lowerable Varioplus roller blind, inclination adjustment, heater or even the unique LED lighting integrated in the folding arms. In the evening warm-white ambient light illuminates the place below the awning. Enjoy living outdoors: during the day and after sun set as well.



### Highlights

- LED lighting in the folding arm
- Modular installation of the PAN 7040
- Variomatic and Variotronic

**Further details on pages 62 + 63**

## Open awnings

HELLA awnings appear light and floating, almost as if they were weightless. Nevertheless they are considered the most stable solutions on the market.



### SOLA

The quality awning for an entry level price



### AREIA 7040

The all-round awning with superior technology



### VIVA 7040

The open awning that can do more

## Half-open awnings

With half-open awnings a rain shelter ensures the necessary protection against weathering for the roller tube and the mechanical parts. The aluminium roof profile protects the cover when the awning is retracted. The awning is open towards the bottom.



### VIVA plus 7040

With roof profile and many functions



### VIVA super 7040

With roof profile and cover tray nearly completely closed

## Cassette awnings

Cassette awnings optimally protect the folding arms and the cover from negative weather effects. When retracted, the awning is completely protected against rain and wind.



### PAN 7040

A design that offers unequalled opportunities



### C2

Discreet design sun shade



### CLEO 5530/7030/7040

A lot of shade in an elegant form



# Pergolas

## Protection for the open living space

### Advantages

- Elegant, timeless design
- Free-standing, wall or ceiling installation
- Sun, rain and wind protection

**“Pergolas bring a Mediterranean feeling of life into your garden and to your terrace.”**



## Pergola variants

Pergolas from HELLA expand the living space to the terrace and the garden. Our pergolas are elegant, timeless and create a protected room outdoors.



**VENTUR**  
Bioclimatic pergola



**SINTESI**  
The innovative pergola

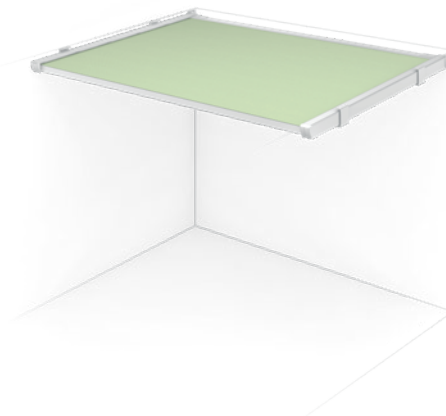

**SINTESI FREE**  
For existing structures or  
between two walls



**VENTUR SIDE and  
VENTUR SIDE M**  
Vertical blind for the  
pergola VENTUR

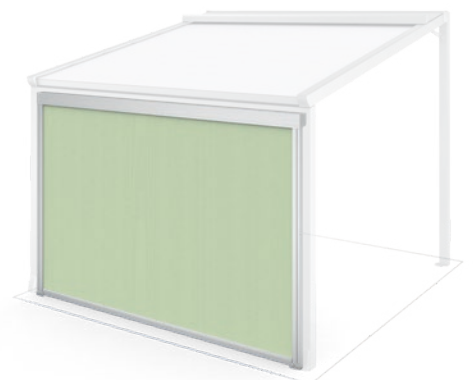

**TERRA SIDE and TERRA SIDE M**  
Vertical blind for pergolas

# Conservatory blinds

Transparency for the protected free space

Conservatory blinds from HELLA turn conservatories into living spaces for the whole year. Attractive, flexibly controllable shading doses the incoming light individually and comfortably. This regulates the indoor climate and creates an extended living space with high quality.





“A conservatory is both  
retreat and open space.  
A place to relax and  
recharge your batteries.”

### Conservatory blinds

- Conservatory awning tenda as slanted or vertical unit

### Indoor sun screen

- Underglass awning Vidrio plus
- Interior venetian blinds
- Interior roller blinds
- Pleated blinds

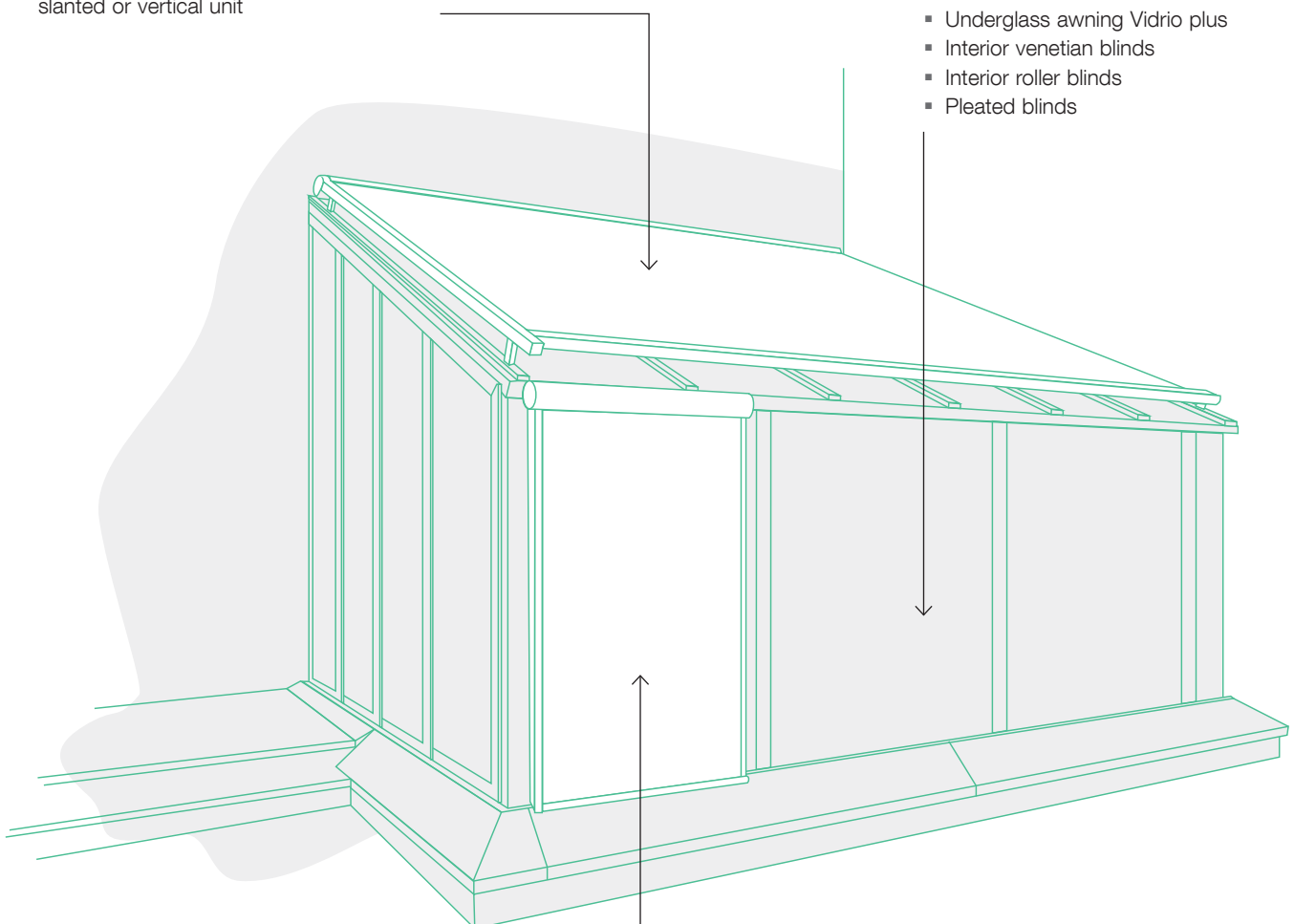

### Outdoor sun screen

- Outdoor blinds & exterior venetian blinds
- Facade blinds





Sun protection  
outdoors & indoors

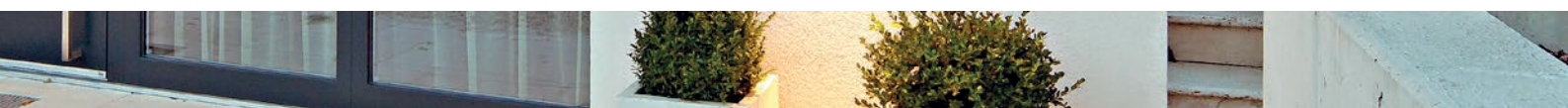

# Outdoor blinds & exterior venetian blinds

The prettiest shape to control the daylight

Functionality and elegance by innovation. Outdoor blinds & exterior venetian blinds from HELLA, do not only darken the rooms – they control and dose the daylight as desired by the user. They provide for comfort in your living space and create the perfect

conditions for productivity in a working environment. Besides the daylight control, they influence the indoor climate, because they reflect the heat of the sun and in this way considerably affect the summerly heat protection.

**“Visual protection,  
comfort and,  
indoor climate  
as desired.”**





## Outdoor blinds

Outdoor blinds from HELLA with high-quality, bordered C-, S- and Z-shaped slats ensure the perfect light – as and when required from pleasantly light to nearly completely dark.



### C-shaped slat (bordered)

The classic variant.  
Visually and technically sound.  
Models: ARO 65,  
ARB 80 and ARB 80 WS



### S-shaped slat (bordered with sealing profile)

Elegant wave contour and perfect daylight control towards the inside.  
Models: AR 63 S ECN®,  
AR 92 S ECN® and AR 92 S ECN® WS



### Z-shaped slat (bordered with sealing profile)

Daylight control with modern geometric shape.  
Models: AR 63 Z ECN®,  
AR 92 Z ECN® and AR 92 Z ECN® WS

## Exterior venetian blinds

Exterior venetian blinds from HELLA with their flat and flexible C-shaped slats are characterised by soft lines and a small package height.

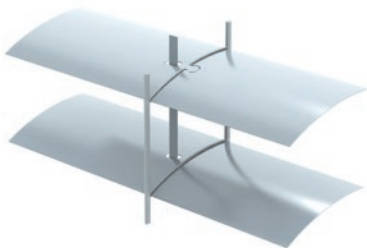

### C-shaped slat (flexible-flat)

The traditional venetian blind with flat slat is available in widths from 50 to 80 mm.  
Models: AF 50, AF 60, AF 80 and AF 80 Plus



### Highlights

- Patented ECN® system
- Bordered Omega deep punchings
- Noise insulating boards with moisture proofing

**Further details on pages 62 + 63**



# Roller shutters

## Maximum protection and optimal indoor climate

Roller shutters from **HELLA** do not only provide optimum protection, they additionally function as efficient “climate buffers”. As a result you save energy, reduce the cost for heating and cooling and create a feeling of security and comfort in your house. We combine comfort and performance with the best HELLA quality.

**During winter** the closed HELLA roller shutters create an air cushion in front of the glass and thus prevent the circulation of air. In this way the thermal loss caused by the window is diminished by up to 30%, which reduces the heating costs enormously.

**During summer** the roller shutters shield up to 85% of the heat of the sun and often replace an air-conditioning system. Modern daylight roller shutters still allow comforting light to enter the room.

## Built-in roller shutters

A built-in roller shutter is directly integrated into the wall and thus invisible. For highest functionality, heat insulation and heat protection are integrated in the system.

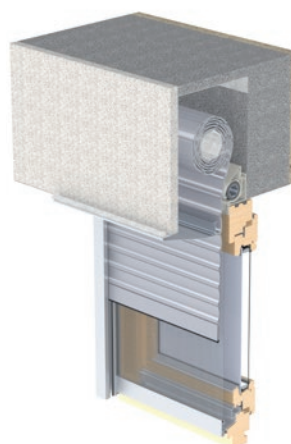

**ERO**  
The classic for uncompromising functionality

## Front-mounted roller shutters

Whether round or square box: Top-mounted roller shutters can flawlessly be integrated into the design of the facade.



### Round design

Front-mounted roller shutter nova with round box, extruded or roll-formed



### Square/slanted

Front-mounted roller shutter nova with a slant of 27°, extruded or roll-formed, also available with plaster base



### Square/quadratic

Front-mounted roller shutter nova with square/quadratic box, extruded or roll-formed, also available with plaster base



### Top-Safe

Burglary-resistant energy saving front-mounted roller shutter with a slant of 27°, extruded



### Highlights

- Daylight profile

**Further details on pages 62 + 63**

# Facade blinds

Light and shade - individual...

Textile exterior blinds provide high climate and light comfort in perfect workmanship and with lots of design options. They are perfectly suitable for vertical facades and window surfaces with modern architectural elements. The side seam guided system from HELLA, which is used for front-mounted shading elements, is a welded-on or sewed-on ultra-stable zip-fastener that guides the textile blind exactly, stably and quietly in the two-part guide rail. So even with high wind speeds, nothing is fluttering. Light design in an airy looking, elegant shape!

**“Textile architecture  
that sets accents and  
creates comfort.”**





## Front-mounted blinds

HELLA front-mounted blinds are perfectly suitable for special sun protection requirements on vertical facades and window surfaces, to which they can be mounted directly at a later time.



**VB 101/201/401**  
Rail guiding



**VB 102/202**  
Rail guiding with sloping projection unit



**VB 103/203**  
Cable guiding



**VB 105/205**  
Drop-arm awning



**VB 107/207/507**  
Side-seam guided glare protection

## Facade awnings

Geometric clearness and structural flexibility are strong points of the HELLA facade awnings that are mounted directly to the facade whereby a certain distance to the windows must be maintained.



**FM 201**  
Rail guiding



**FM 202**  
Rail guiding with sloping projection unit



**FM 203**  
Cable guiding

## Vertical awnings

Vertical awnings from HELLA function like a second building envelope and can be mounted nearly invisibly.



**SM 101**  
Vertical awning with rail guiding



**SM 102**  
Vertical awning with rail guiding and sloping projection unit



**SM 103**  
Vertical awning with cable guiding



### Advantages

- VB 507 with plaster base, perfectly suitable to be completely plastered-in in the facade, with integrated guide rails and optionally with rear insulation
- VB 507 Recess: special design for recess installation



# Interior blinds

Pleasant light, good mood

Interior shadings from HELLA are nice, flexible and effective. Interior roller blinds, interior venetian blinds, pleated blinds and vertical blinds offer a wide range of creative options to adapt the light and indoor climate in living and working rooms to the needs of the user. Individual and functional sun protection can be so good.

**“Interior blinds offer a wide range of creative options to adapt the light and indoor climate in living and working rooms to the needs of the user“**

## Interior roller blinds

Whether self-supporting, for skylights or large surfaces - interior roller blinds provide the perfect view and glare protection.



## Blackout element

Creatively playing with light and shade.



## Interior venetian blinds

Optimal control of the sunlight creates a comfortable atmosphere in the room.

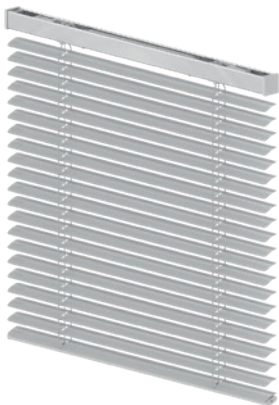

## Pleated blind

Always in shape, the pleated blinds provide protection from unwanted glances, reduce the brightness and serve as optimum protection against the heat.

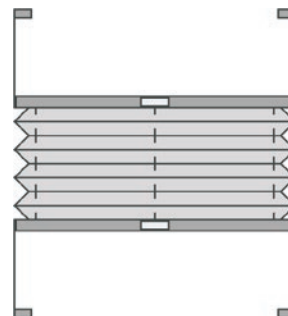





Insect screens

# Insect screens

Perfect protection against all kinds of insects for any door and window

A proven system for the effective protection against insects. For any window and door opening, any constructional situation and for any climate zone - HELLA provides the perfect protection against insects – effective and beautiful, perfectly integrated and convenient to operate. Even subsequent installation is no problem. In everyday life you become aware that an insect screen must suit many different situations. HELLA knows this and therefore offers insect screen fabrics that provide from the looking through to the protection against pollen and mice almost everything - and this in many different variants and colours.

**“Effective protection against pests - creates comfort and relaxation.”**



## Insect screen frame



### ISR, ISD and IST

Clamping, swing and slide frames fit all standard doors and are the perfect solution for a seasonal protection against insects.

## Pleated insect screen

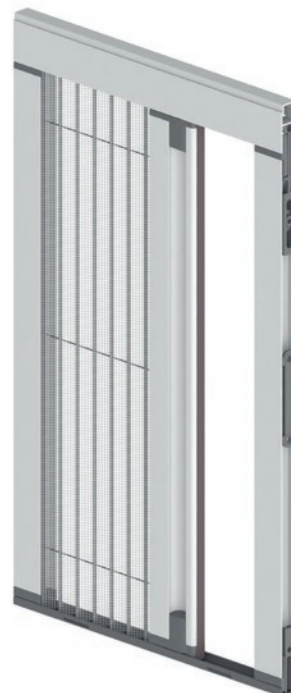

### Pleated insect screen ISPL18

The HELLA insect screen pleated blind is perfectly suitable for doors and passage ways.

## Insect roller blinds



### Insect roller screen IS13

Our insect roller screens offer a perfect protection against unwanted guests and can be opened or closed as needed.



### Installation of the insect roller screen

A proven system for the effective protection against insects. Perfectly adapted to any door and window.

### Advantages

- Broad and deep portfolio for all installation variants and demands
- Multifarious types of insect screen fabrics









Solutions for  
building shells





# TRAV<sup>®</sup> frame Soffit systems

Energy saving and  
comfort in one system

How do you integrate the complex combination of window, window sill and sun protection in any facade in a technically simple and structurally perfect way? The answer is TRAV<sup>®</sup>frame.

A building block is installed in the window opening that seamlessly integrates the window and the sun protection. The easy installation saves time and costs. Cracks in the plaster, thermal bridges and other constructional faults are nearly eliminated. Therefore, energy values and noise insulation are brilliant.

## Advantages

- Planning security due to compliance with all standards
- Time and cost reduction due to quick and easy installation
- High flexibility in the selection of window and sun protection
- Less installation risk, because sources of trouble are reduced
- Energy savings due to perfect thermal insulation with tried and tested insulating materials
- Visual harmony due to seamless integration into the facade
- Flexibility in planning due to individual customization
- The security of HELLA quality development
- Cost efficiency during construction phase

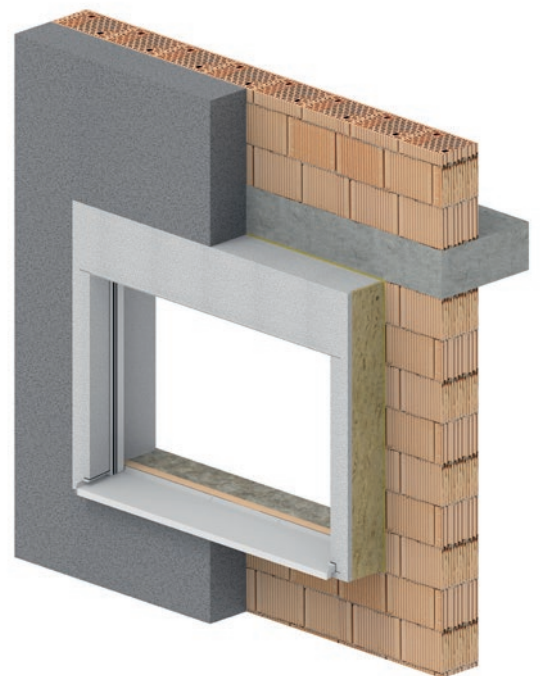

**“Window and  
sun protection  
quick, standardized and  
reasonable installation.”**

With the TRAV®frame soffit systems HELLA sets new standards for the up-to-date installation of sun protection systems and windows, not only in terms of effort, but also with regard to energy efficiency. The innovative solutions allow the technically simple and structurally perfect integration of the complex combination of window, window sill and sun protection in any facade in one go.

A building block is mounted in the window opening that seamlessly integrates all components. This simple type of installation does not only save time and money. Thermal bridges, cracks in the plaster and other constructional faults are nearly eliminated as well.

## TRAV®frame Outdoor blind



Outdoor blinds and exterior venetian blinds integrated together with the window in the facade. Window position centred or flush on the inside; optional with integration of the insect roller screen

## TRAV®frame Roller shutter



Roller shutters integrated together with the window in the facade. Window position centred or flush on the inside; optional with integration of the insect roller screen

## TRAV®frame Screen



Textile sun protection integrated together with the window in the facade. Window position centred or flush on the inside; optional with integration of the insect roller screen

## TRAV®frame window frame



For windows with folding shutters or without sun protection; Window position centred or flush on the inside

# Box systems

Perfect and invisible integration of sun protection products in the facade

Window and sun protection merge into a flexible, tailor-made and perfectly mounted unit. Box systems from HELLA save time and costs, avoid construction errors, optimise the construction quality and meet the standards of the future. Whether roller shutters, outdoor blinds, venetian blinds, textile shadings or insect screens –any protection against light, view and noise can seamlessly be integrated in the various HELLA box systems. The sun protection, insect screen and weather protection are perfectly stowed away, nothing rattles, everything runs smoothly, is stable and made-to-last.

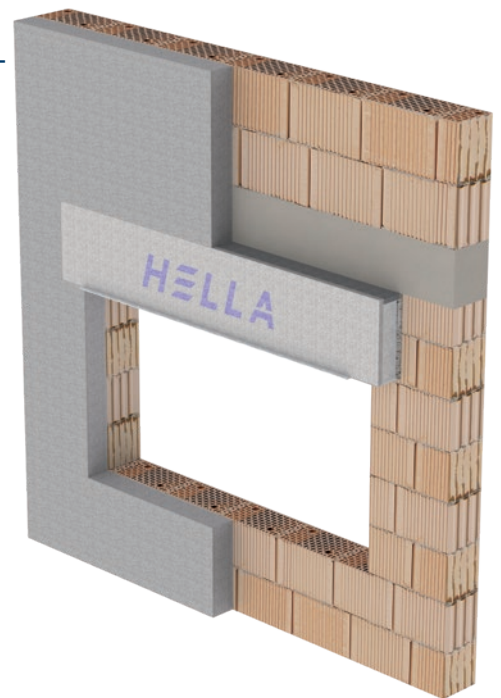

## TRAV® systems

The custom-made TRAV® lintel box systems allow the invisible integration of the sun protection product in the facade of a building. They convince by usefulness, easy installation and flexibility.

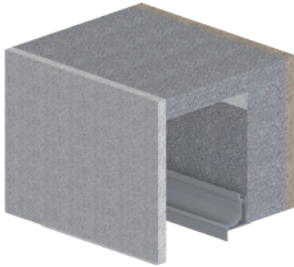

### TRAV®Aktiv

Due to the functional ceiling and side part insulation, the system has a high heat and noise insulation.

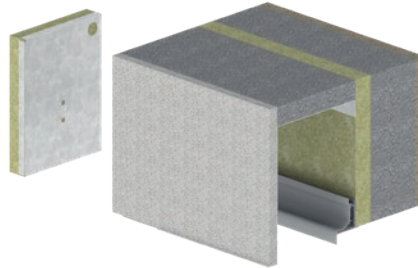

### TRAV®Aktiv plus

Structurally optimised solution for recesses with excellent insulation performance. Protects against sound immissions and fire spreading.

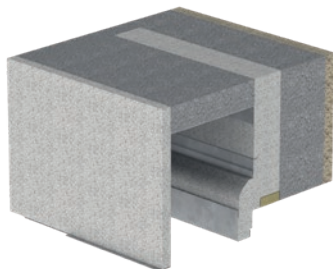

### TRAV®Protect

The new generation of lintel box systems - long-lasting and protecting. With frame insulation for highest thermal comfort.

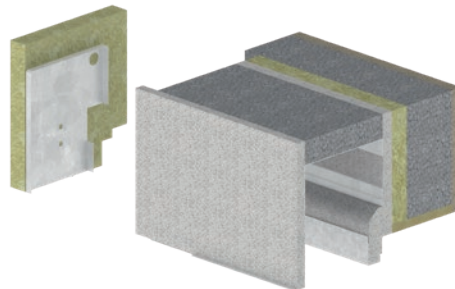

### TRAV®Protect plus

The new generation for sustainable construction and action with additional innovative feature. With frame insulation for highest thermal comfort.

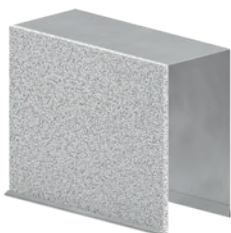

### TRAV®Nische type 1

with plaster base on the outside, without insulation body on the inside

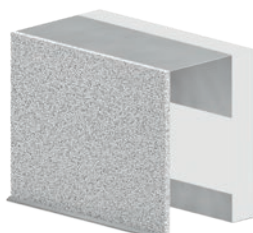

### TRAV®Nische type 2

with external plaster base, with insulation body on the inside, without stop bracket

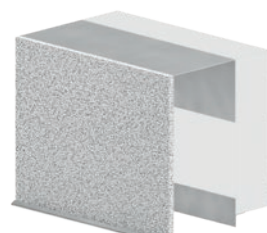

### TRAV®Nische type 3

with external plaster base, with insulation body on the inside, with stop bracket

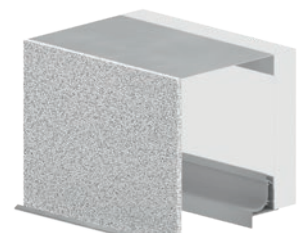

### TRAV®Nische type 4

with external plaster base, with insulation body on the inside, with plastic stop profile

# Top-mounted elements

Top-mounted boxes that are already mounted on the window

Top-mounted boxes from HELLA for roller shutters, exterior venetian blinds and outdoor blinds are pre-installed on the window and delivered by the window supplier. Thanks to the coordinated integrated window and sun protection system, the installation time on-site is reduced significantly. This solution is especially suitable for new buildings, but can also be used for older buildings when

the windows are replaced. HELLA offers a wide range of excellently insulated top-mounted boxes that, after plastering, are nearly invisible on the facade, reduce thermal bridges and allow convenient inspections due to easily accessible openings.



## Top-mounted plastic elements

Top-mounted plastic elements from HELLA are durable and easy to maintain. Different options are available for roller shutters, venetian blinds and outdoor blinds.



### TOP DUO

TOP DUO from HELLA is perfectly suitable for new buildings and the use of maxi profiles.

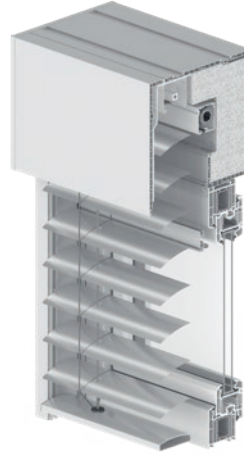

### TOP DUO store

TOP DUO store from HELLA is perfectly suitable for outdoor blinds and exterior venetian blinds.



### TOP MINI plus

Available in three sizes, the TOP MINI Plus is the perfect solution for low blind frames.

## Top-mounted elements THERMplus

Top-mounted elements TOP FOAM made of Neopor combine best insulation values with highest flexibility. The flexibility of the TOP FOAM top-mounted elements is shown by the different box heights and depths for all installation situations. Thanks to its variety, the TOP FOAM is suitable for all door and window openings in new and old buildings. The TOP FOAM will be available in the following designs: For roller shutters with inspection from the bottom side or from the outside, for outdoor blinds & exterior venetian blinds as well as for side seam guided fabrics. Due to its clip technology it is very installation-friendly and is available with universal as well as window-specific clip adapters.

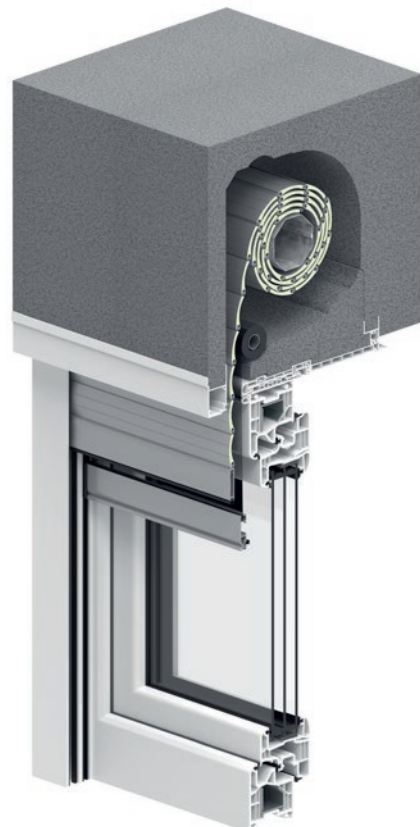







HELLA  
Control systems



# ONYX<sup>®</sup>

## Simply retain control

The Smart Home System ONYX.HOME was specially developed for the operation of sun protection products. Venetian blinds, outdoor blinds, awnings and roller shutters are conveniently controlled via smart phone, tablet, hand-held radio transmitter or even fully automatically.

All sun protection products are graphically displayed in the free ONYX<sup>®</sup> app. The position of the sun screen is already visible during control. All products can be visually marked with colours in the app. In addition, it is possible to assign names to each individual cover for easier identification and operation.

Controlling the sun protection products via pushbutton or the hand-held radio transmitter ONYX.CLICK is also possible. This gives children or guests, who have no access to the app, the possibility to operate the sun protection product.



## 1. CONFIGURE

A QR code is the link between the devices. With the help of the ONYX® App you simply scan the code of a control device to add it to your system. Enter a name and a colour and you already have full control.

## 2. GROUP

Group your sun protection products without any effort and colour them in order to keep track.

## 3. CONTROL

Light and shade of your home can easily be controlled through gestures – even on the go. Whether individual sun protection products or entire groups, ONYX® keeps things easy.



ONYX.HOME

## Advantages

- Easy configuration: scan and get started
- Live feedback on position and movement of the sun protection product
- Automatic functions are individually adjustable for each sun protection unit (wind/sun/astro/time/twilight)
- Also easy and inexpensive for renovation
- Security through transparent access control
- Routing function for the best possible data transmission due to reliable forwarding of the signals
- Secure encryption between devices and smartphone/tablet



## Center box and control devices

The ONYX.NODE and ONYX.CONNECTOR control units connect to the center box ONYX.CENTER via radio, thus transmitting the signals to the motor and the sun protection products. If you prefer taking control via an app, a pushbutton or a hand-held radio transmitter, then ONYX.NODE is required. If control via app or hand-held radio transmitter is sufficient, your products will be equipped with the ONYX.CONNECTOR.



### ONYX.CENTER

The center box serves as an interface between smart phone and the individual control devices and communicates via a wireless radio connection. It transmits radio commands bidirectionally so that the exact current position of the sun screen is displayed via the live feedback in the app.

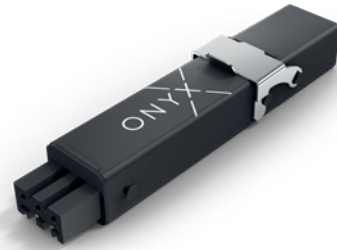

### ONYX.CONNECTOR

The ONYX.CONNECTOR is situated next to the motor of the sun protection product. It is controlled via the app or the hand-held radio transmitter ONYX.CLICK.



### ONYX.NODE

The ONYX.NODE is mounted behind the pushbutton in the wall and connected to the motor cable. In this way the sun protection product can be controlled by the pushbutton, the app or the hand-held radio transmitter ONYX.CLICK.

## Weather sensor



### ONYX.WEATHER

The weather sensor ONYX.WEATHER logs the external weather influences such as wind speed, sun intensity and temperature on the facade.

## Hand-held radio transmitter



### ONYX.CLICK

ONYX.CLICK is the hand-held radio transmitter for the control of sun protection products. It serves as an extension for the center box ONYX.CENTER, but it can also be used without the box in the stand-alone operation.



## Automatic functions

ONYX.HOME has numerous automatic functions that can be set individually for each sun protection product. Running the time and astro programme is possible without additional accessories. Wind and sun-based functions require measured data from an ONYX.WEATHER weather sensor.



Sun



Wind

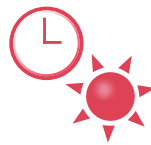

Time/Astro



Twilight

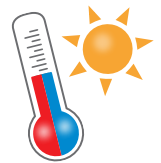

Temperature on the facade



## Safety

Unlike most other solutions currently available on the market, ONYX® is designed with security in mind. However, this security is transparent for the customer and not perceived as disturbing.

### Some examples are:

- Access control for all devices via the ONYX® app
- Encryption between ONYX.CENTER and your smartphone
- Additional security through the use of QR codes

### Secure data exchange

ONYX® communicates via IP, enabling data exchange with other systems. Nevertheless, great importance is attached to encryption, only authorized participants are allowed to access the interface.





# References

# Exactly my mood



The HELLA range of products meets the highest design and functional demands. First-class materials are carefully processed in the HELLA plants. Continuous quality checks ensure durability and quality down to the last detail.





**Daylight  
is our  
material**

# Living with HELLA

## Villa, Lake Garda

The villa, well thought out and thoroughly planned down to the last detail, offers a fabulous panoramic view of Lake Garda. In order to leave no wishes unfulfilled and to guarantee the resident a restful stay, a complete sight and sun protection concept was developed in addition to every living comfort. The built-in textile vertical awnings offer protection from sunlight and, nevertheless, ensure a nearly clear view towards the outside. The burglar-proof roller shutters Top-Safe protect against unwanted visitors, and the insect roller screens from HELLA offer protection against insects.



Atmosphere  
by  
design & function



# Living with HELLA



## Awning

- Heinersreuth, Germany
- Cassette awning PAN 7040
- Special feature: Modular installation



## Awning

- Lienz, Austria
- Awning CLEO 7040
- Special feature: LED lighting



## Pergola

- Bologna, Italy
- Pergola VENTUR



## Pergola

- Lienz, Austria
- Pergola SINTESI
- Special feature: Special construction due to shortage of space



### Outdoor blinds and insect screens

- St. Lorenzen, Italy
- Outdoor Blinds AR 92 Z
- Built-in roller shutters ERO with aluminium profile A37
- Insect roller screens and pleated insect screens



### Roller shutters

- Sillian, Austria
- Built-in roller shutters ERO with aluminium profile A37



### Solutions for building shells, outdoor blinds, roller shutters, insect screens, awnings and ONYX®

- Amlach, Austria
- Soffit system TRAV®frame, box system TRAV®Nische
- Outdoor blinds AR 92 S
- Built-in roller shutters with daylight profile
- Insect roller screens and pleated insect screens
- Awnings VIVA plus 7040
- ONYX® control



### Solutions for building shells, outdoor blinds, roller shutters, insect screens and ONYX®

- Nussdorf-Debant, Austria
- Box system TRAV® and TRAV®Nische
- Outdoor blinds AR 92 S
- Built-in roller shutters ERO with aluminium profile A37
- Insect roller screens
- ONYX® control

# Working with HELLA

## DLR Lampoldshausen

The DLR forum for space travel drives in Lampoldshausen is a special building. The geometry of the bent facade does not allow a standard sun protection solution: Almost all of the 44 HELLA venetian blinds were adapted to the conditions of the double-bent facade and the differing individual glass panes that are up to five meters high. Tensioning elements and Z-shaped consoles were also manufactured as special solutions.



## Atmosphere by room quality



The 80 millimetre wide, delicately dimensioned and silver-coated slats emphasise the filigrane aesthetic of the glass facade. They are exceptionally stable and highly flexible at the same time. Thanks to their special aluminium alloy, the slats easily withstand even strong wind loads and always return to their original condition.

# Working with HELLA



## Pergolas

- Hotel "Ansitz Kematen"
- Klobenstein, Italy
- Four pergolas SINTESI



## Pergolas

- Restaurant "Badwirt"
- Lienz, Austria
- Four pergolas SINTESI
- Special feature: Special design



## Outdoor blinds

- University of Applied Sciences St. Pölten
- St. Pölten, Austria
- 200 Outdoor blinds AR 92 Z WS
- Special feature: Daylight control system



## Outdoor blinds, interior roller blinds, conservatory and facade blinds

- Credit institution/bank "CSOB"
- Prague, Czech Republic
- 868 Outdoor blinds AR 80
- 1023 Interior roller blinds
- 14 Conservatory blinds tenda
- 134 Vertical awnings SM 103





### Exterior and interior venetian blinds

- Travel agency "Eurotours"
- Kitzbühel, Austria
- 123 Exterior venetian blinds AF 80
- 42 Interior venetian blinds IF 16



### Facade blinds

- Kindergarten Bruneck
- Bruneck, Italy
- 63 Vertical awnings SM 103
- 18 Facade awnings FM 203



### Facade blinds and awnings

- Office building "Bene"
- Waidhofen/Ybbs, Austria
- 102 Facade awnings FM 202
- 16 Awnings



### Conservatory blinds

- Car dealer "Zubak"
- Zagreb, Croatia
- 9 Conservatory blinds tenda plus



# Our customers report

Individual  
solutions,  
**fine**  
**design**

Adapted to your special requirements in the highest quality designs.



## **Family Oberwasserlechner**

"Our house is spacious and open and provides a lot of room to live and play. Outdoor blinds, interior venetian blinds

and insect screens from HELLA provide the perfect balance between "outside" and "inside"."





**Barbara Scherzer**

“As an architect I designed my own house, with rooms that extend to several levels and are aligned towards the sun. Sun and climate protection are therefore not only functional to me, but part of the architecture. Daylight is the most important design element in my house.”



**Peter Paul Wurzer**

“I live in a penthouse apartment with a wonderful view of the mountains. My terrace is shaded by a HELLA awning, and HELLA outdoor blinds ensure the perfect light and indoor climate both in summer and winter. And all of this for many years.”





HELLA

# HELLA highlights

The following details are only a few examples for the quality awareness and innovative strength that influence the development of all HELLA products.

## LED lighting in the folding arm

The LED lighting is optionally available for the awnings AREIA 7040, VIVA 7040, CLEO 7040 and PAN 7040. Integrated on the bottom side of the folding arms, warm-white ambient light illuminates the place below the awning. LEDs are dimmable, have a long lifespan and are extremely energy-efficient. The awning lighting is controlled via radio, the cables are clean and to the greatest possible extent discreetly hidden in the construction of the awning.

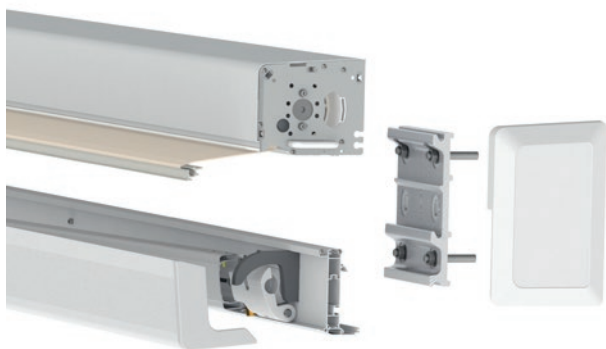
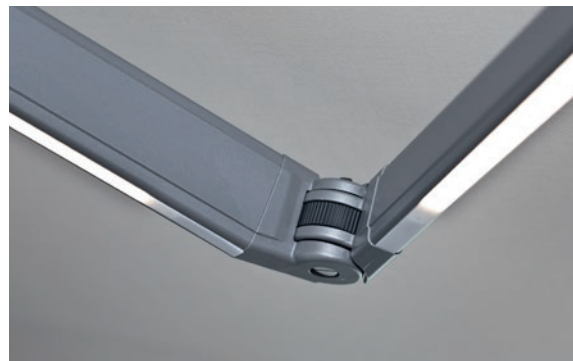

## PAN 7040 – Modular installation

The elegant awning PAN 7040 does not only set standards in terms of design. Due to its modular design, an especially easy installation is ensured. Even with a maximum width of seven metres and a maximum sloping projection of four metres, the installation is, thanks to the clever modular design, feasible with two persons only.

## Variomatic and Variotronic inclination adjustment

To make sure that the extracted awning gives shade at any sun position, the Variomatic inclination adjustment from HELLA allows an inclination of the awning from 0° to 40°. Using a crank handle or a Variotronic motor, the tilting mechanism and as a result the inclination of the awning can be optimally adapted to the position of the sun.

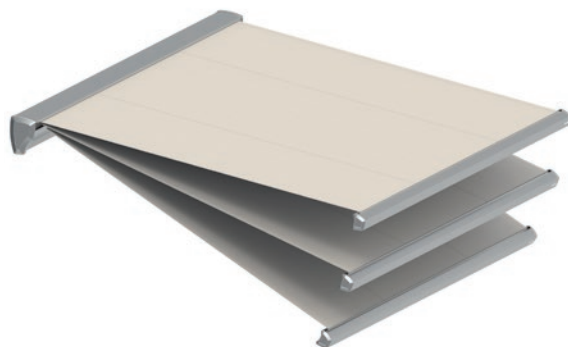



### Stainless steel clip cam belt (ECN®)

The patented stainless steel clip cam belt - short ECN - is a woven carrying tape made of polyester with double aramide reinforcement (Kevlar, Twaron) and sprayed clip cams made of UV-resistant plastic. These are connected to the slats via chromium steel clamps. Due to the vertical and horizontal rotatability of this connection, a uniquely exact packaging is possible. When raising, the tape forms perfect loops, the curtain closes perfectly and the package remains small.

### Omega punching

HELLA replaced the plastic ladder cord fastening devices, which may become brittle and perish over the years, with the smart Omega punching. This way the tape is connected to the slat without auxiliary device, such as plastic eyelets. This type of connection is especially discreet, very stable and nearly maintenance-free.

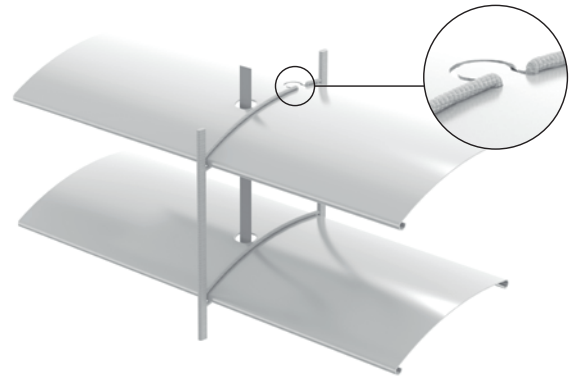

### Noise insulating boards with moisture proofing

HELLA's noise insulating boards for spacers and tensioning elements do not only reduce the vibration noises on facades and windows. At the same time they seal the screwed joints reliably against moisture, which in the worst case could cause the rotting of the blind frame.

### Daylight profile

With traditional roller shutters the closing of the profiles darkens the room completely, an effect which is not always desired. The daylight profile from HELLA is designed with translucent plastic elements in-between the slats. In this way everything is possible: from the view to the outside to the free of stripes transport of the daylight into the interior of the room.





# 60 years HELLA

From a family company to an international company group

For 60 years it has been our passion to put the home of our customers in its true light and to create their outdoor living space. In the year 1959, the family company HELLA started with two employees the production of venetian blinds in different designs in Abfaltersbach. Thanks to a strong organic growth and interna-

tional acquisitions, the company developed to a leading and internationally operating, family-owned and operated enterprise within the sun protection industry, with by now more than 1,300 employees.

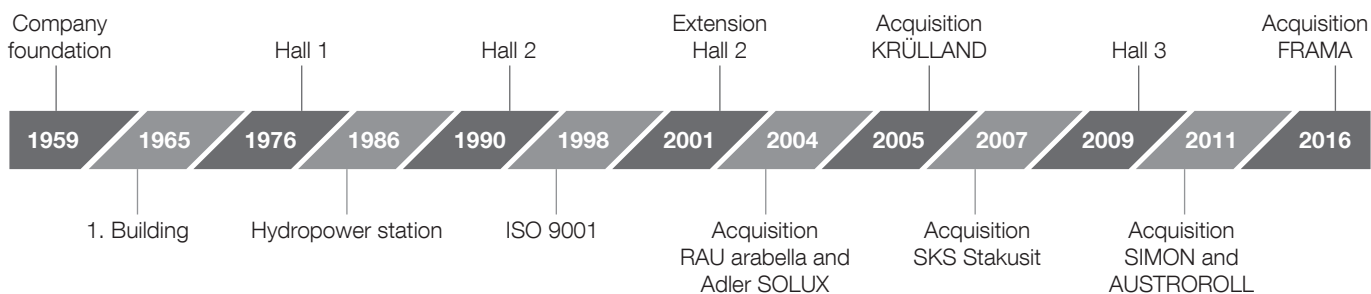



# Our vision

We create unique atmosphere  
for a healthier life



# Our mission

We understand atmosphere in all dimensions  
and hence develop effective products  
and services for our clients.





**The long-established company HELLA**

is one of the leading European manufacturers of sun and weather protection systems and stands for functional innovations, visionary design and maximum customer benefit. The world of sun and weather protection is constantly changing due to numerous patented developments.

From the first venetian blind that was produced in East Tyrol in 1959 to the high-tech control devices for the intelligent house of the future, we are driven by only one desire: To develop something really good. Since then the brand HELLA convinces with innovative strength and a large variety of products – all of top quality and perfect function. Today, HELLA is an internationally significant initiator for the development of sustainable systems for sun and weather protection. Whether for a single-family home or a large project – we are always close to our customers.

**HELLA is always an original - innovative and made-to-last.**

HELLA has created new standards through ground-breaking technologies. Our products have the quality of the original product, they are sophisticated and sustainable and produced in modern, environmentally friendly plants.

# PARTNERSHIP WITH HANDSHAKE QUALITY

## Your HELLA benefits

- Perfect support due to many specialist shops and selected retail partners
- High-quality expert advice from qualified sales assistants
- Best price-performance ratio
- Service provided by trained technicians
- Comprehensive guarantees
- Finest product quality due to development and production at our own premises
- Ecologically oriented quality with maximisation of energy savings
- Successful since 1959

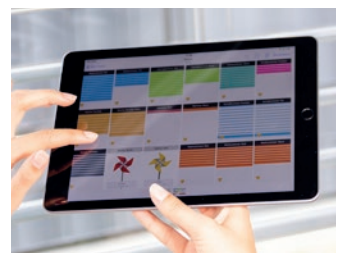



**HELLA Sonnen- und  
Wetterschutztechnik GmbH**

9913 Abfaltersbach 125

P +43 4846 65 55

office@hella.info

**[www.hella.info](http://www.hella.info)**

